



English

norcool
cold by nature



OPERATING & INSTALLATION INSTRUCTIONS



CAVE 110 DZ | CAVE 160 DZ



Please visit www.norcool.no for operating & installation instructions in other languages.



ENERG Y IJA
енергия · ενεργεια
IE IA

norcool CAVE 110 DZ



ENERGIA · ЕНЕРГИЯ · ΕΝΕΡΓΕΙΑ
ENERGIJA · ENERGY · ENERGIE
ENERGI

274
kWh/annum



x111



42 dB

2010/1060



ENERG Y IJA
енергия · ενεργεια
IE IA

norcool CAVE 160 DZ



ENERGIA · ЕНЕРГИЯ · ΕΝΕΡΓΕΙΑ
ENERGIJA · ENERGY · ENERGIE
ENERGI

285
kWh/annum



x160



42 dB

2010/1060

1. Safety Instructions & warnings	5
2. Components and parts	6
3. Installation.....	7
Before using your appliance	7
Free standing or built-in installation.....	7
Electrical connection	8
4. Appliance features and wine storage.....	9
5. Operating your appliance	11
6. Care and maintenance	13
Automatic defrost.....	13
Cleaning	13
Vacations.....	13
Moving your appliance.....	14
Energy saving tips	14
7. Troubleshooting guide.....	15

To reduce the risk of fire, electrical shock, or injury when using your appliance, follow these basic precautions:



This appliance is not intended for use by persons (including children) with reduced physical, sensory or mental capabilities, or lack of experience and knowledge, unless they have been given supervision or instruction concerning use of the appliance by a person responsible for their safety.

Children should be supervised to ensure that they do not play with the appliance.

Read all instructions before using the wine or beverage cooler.

WARNING: Risk of child entrapment.

To avoid the possibility of child entrapment, please take the following precautions before throwing out the appliance:

- Remove all doors from the unit.
- Leave the shelves in place so that children may not easily climb inside.

Never allow children to operate, play with, or crawl inside the appliance.

Refrigerants: All refrigeration products contain refrigerants, which under the guidelines of federal law must be removed before disposal of product. It is the consumer's responsibility to comply with federal and local regulations when disposing of this product.

WARNING: Accidents can occur as a result of the product overturning. To prevent this product from tipping over, it must be fixed to the wall with the accompanying mounting brackets. See photo of brackets under Installation.

Wall fasteners are not included, as different wall materials require different types of fasteners. Use fasteners that fit the walls of your home. For advice on suitable attachment systems, contact your local specialist dealer.

Never clean appliance parts with flammable fluids. The fumes can create a fire hazard or explosion.

Do not store or use gasoline or any other flammable vapors and liquids in the vicinity of this or any other appliance. The fumes can create a fire hazard or an explosion.

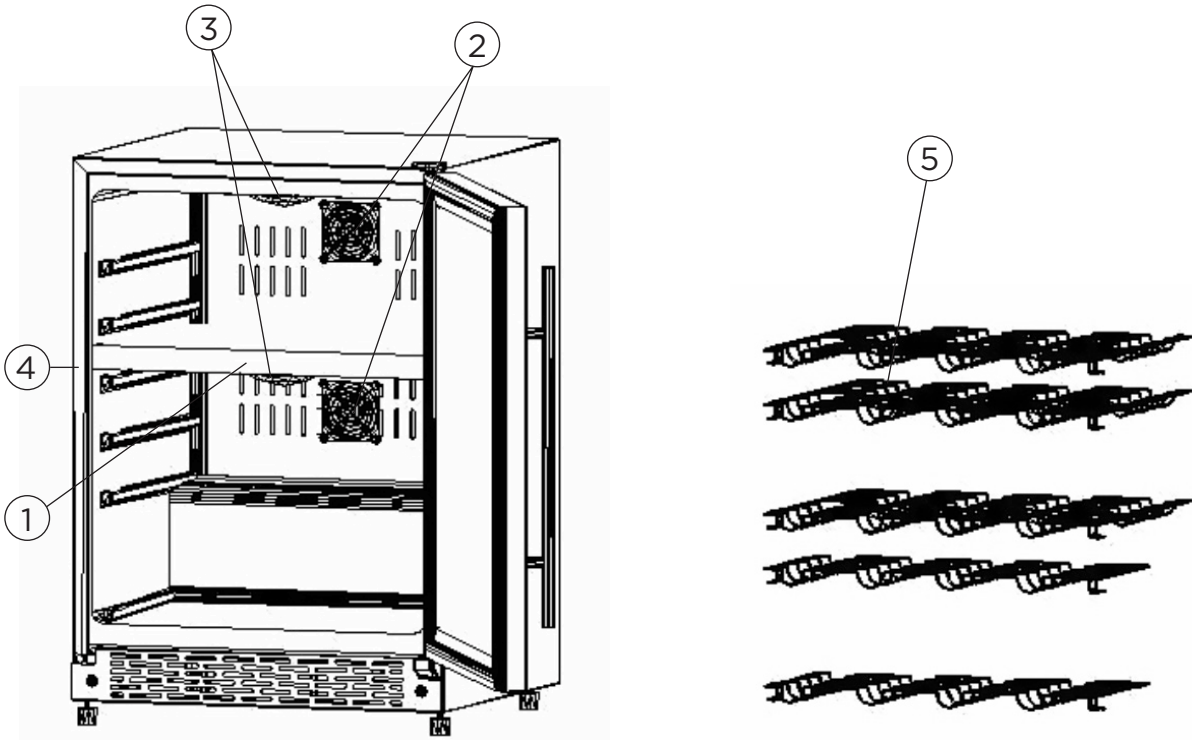

Parts

- 1. Temperature control and display
- 2. Circulation fan
- 3. Interior light
- 4. Cabinet
- 5. Wooden shelves

Upper zone controller/display

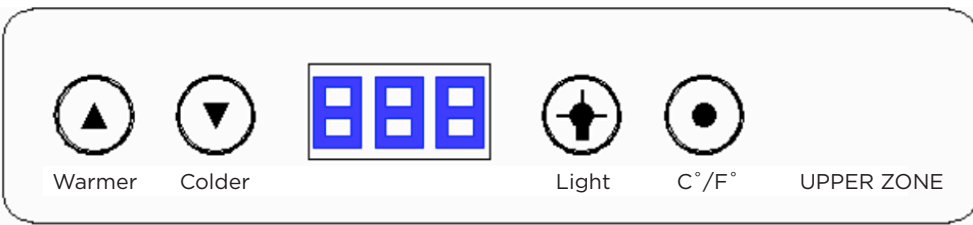

Lower zone controller/display

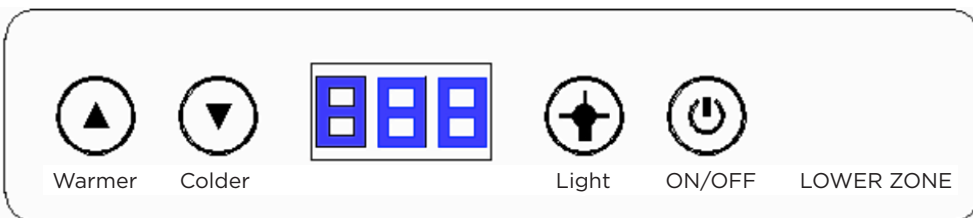

Before using your appliance

- Remove the exterior and interior packaging.
- Before connecting the appliance to the power source, let it stand upright for approximately 4 hours. This will reduce the possibility of a malfunction in the cooling system from improper handling during transportation.
- Clean the interior surface with lukewarm water using a soft cloth.

Free-standing installation

- Locate the appliance away from direct sunlight and sources of heat (stove, heater, radiator, etc.). Direct sunlight may affect the acrylic coating and heat sources may increase electrical consumption. Ambient temperature below 68°F (20°C) or above 90°F (32°C) will hinder the performance of this appliance. **This unit is not designed for use in a garage or any other outside installation.**
- Avoid locating the appliance in moist areas.
- Plug the appliance into dedicated, properly installed-grounded wall outlet. Do not under any circumstances cut or remove the third (ground) prong from the power cord. Any questions concerning power and/or grounding should be directed toward a certified electrician or an authorized service center. **This unit is not designed to be installed in an RV or used with an inverter.**
- After plugging the appliance into a wall outlet, allow the unit to cool down for 3 ~ 4 hours before placing wine bottles or beverage cans in the appliance.

The brackets below must be used to prevent the product from tipping over.

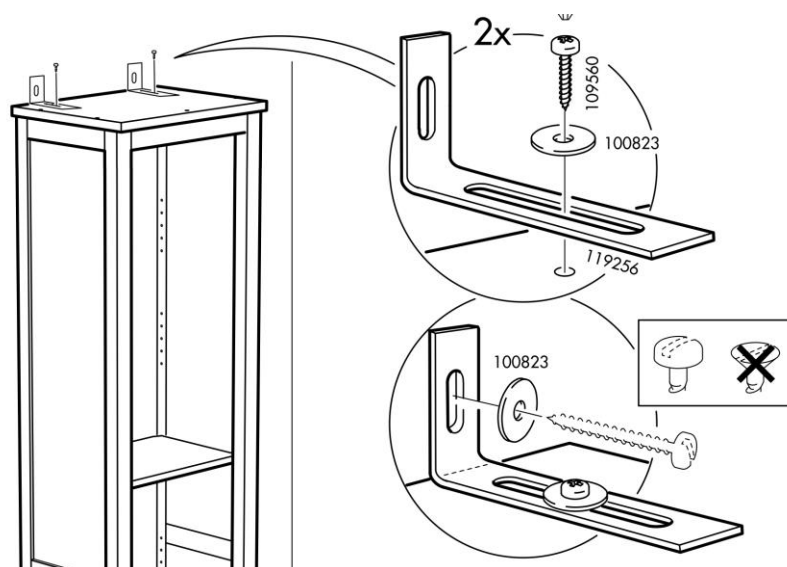

Electrical connection

This appliance should be properly grounded for your safety. The power cord of this appliance is equipped with a three-prong plug which mates with standard three prong wall outlets to minimize the possibility of electrical shock.

Do not, under any circumstances, cut or remove the third ground prong from the power cord supplied.

This appliance requires a standard 220-240 Volt A.C. /50Hz electrical outlet.

This appliance is not designed to be used with an inverter.

The cord should be secured behind the appliance and not left exposed or dangling to prevent accidental injury.

Never unplug the appliance by pulling the power cord. Always grip the plug firmly and pull straight out from the outlet.

Do not use an extension cord with this appliance. If the power cord is too short, have a qualified electrician or service technician install an outlet near the appliance. Use of an extension cord can negatively affect the performance of the unit.

4. Appliance features and wine storage

Two temperature zones

- There are two zones in this appliance (upper zone and lower zone)
- Each zone has its independent temperature control and display.
- Each of the two zones can be used to store wine bottles or beverages.

Interior light

Each zone has its own interior light, which can be switched on or off by pressing the pad (light) on the control panel. Long-life and high efficiency LEDs are installed for durability and energy saving.

Engaged wine shelves

- All the shelves have tabs to engage the cabinet on both sides.
- Any of the shelves can be removed to accommodate larger bottles.

To remove a shelf:

- Remove all bottles from the shelves.
- To remove the shelf, unlock the clip on the gliding rail, both sides. Push the right side clip down and the left side clip up at the same time.

NOTE: Ensure that the clips are firmly engaged in place before storing any bottles.

CAVE 110 DZ

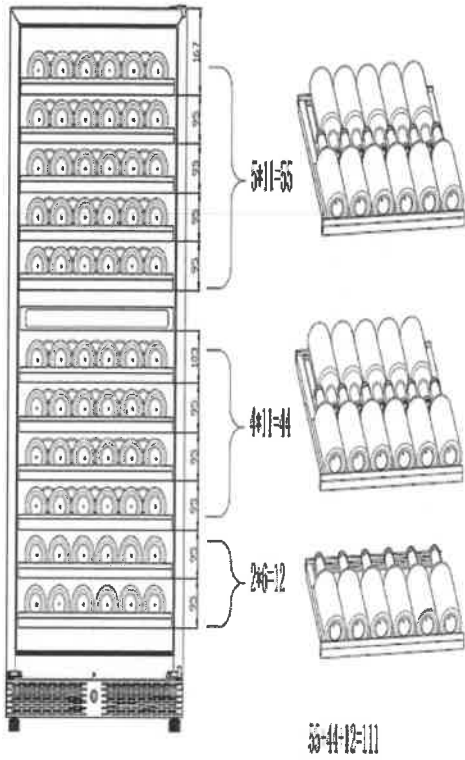

CAVE 160 DZ

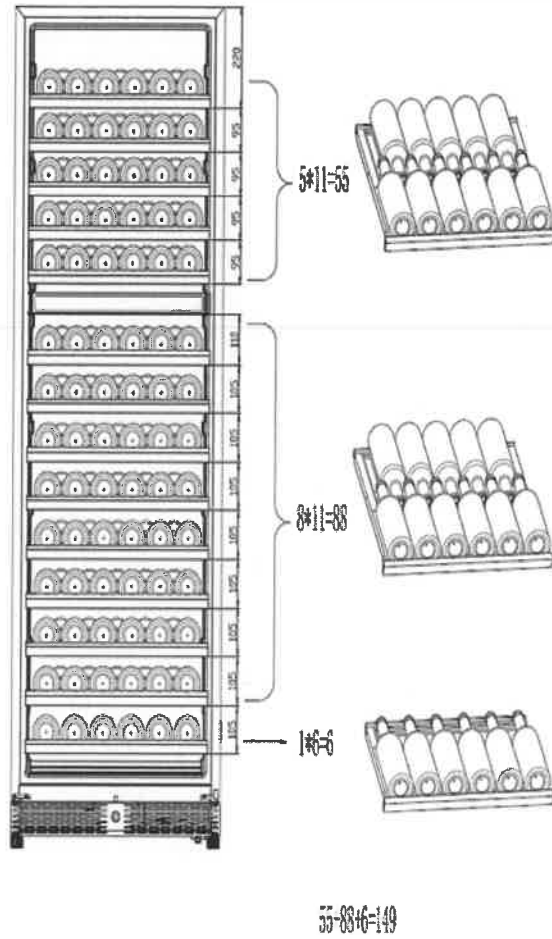

Capacity	CAVE 110 DZ	CAVE 160 DZ
750 ml bottle	111	149
Upper zone	55 (pull out wooden shelves x5)	55 (pull out wooden shelves x5)
Lower zone	44 (pull out wooden shelves x11) + 12 (half pull out shelves x2)	88 (pull out wooden shelves x11) + 6 (half pull out shelves x1)
Storage volume (Lt)	300	400
Pull-out shelf dimension	468mm x 535mm	468mm x 535mm

Upper zone controller/display

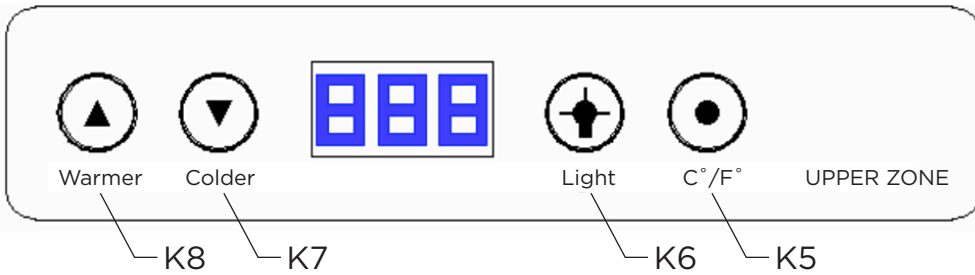

Lower zone controller/display

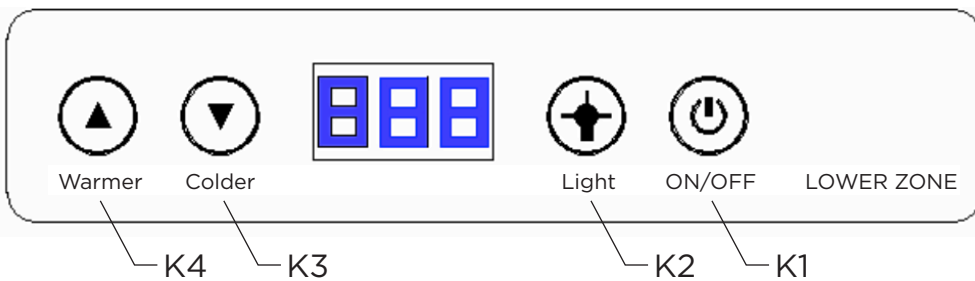

Temperatures for wine storage

- Champagne 5°C ~ 8°C
- White wine 9°C ~ 14°C
- Red wine 15°C ~ 18°C

Temperature control and display

1. When the unit is plugged both indicators will light for 3 seconds (display 888), and an audible beep will be heard.
2. The temperatures in the upper zone and lower zone can be independently controlled and displayed.
3. The temperature in either zone can be controlled between 5°C to 20°C5. (The zone temperature may have a tolerance of +/-3°C from setting depending on different loading and ambient conditions.)

Memory device

When restarting the appliance after a power failure, the memory device will keep the last saved settings.

K1 key (ON/OFF)

Power switch: press and hold the key to turn on/off the appliances.

K2 key (lower interior light)

Interior light control switch of the lower zone: To turn on or off the interior light, press the K2 key once for each time. The interior light will keep lighting if it is not

turned off.

K3/K4 key (colder /warmer)

Temperature setting switch of the lower zone: Under normal conditions the temperature display will flash and indicates the current temperature of the lower zone. Pressing the K3/K4 key when setting the temperature, the temperature displayed will decrease or increase in an increment of one degree. If the K3 (colder) or K4 (warmer) key is pressed and held for one second, the temperature displayed will decrease or increase in a speed of one degree per second.

The temperature display will flash 5 seconds after the temperature been set, and indicates the current temperature.

K5 key (C°/F°)

The temperature display can be changed between Celsius and Fahrenheit by pressing the K5 key.

K6 key (upper interior light)

Interior light control switch of the upper zone. To turn on or turn off the interior light, by pressing the K6 key once for each time. The interior light will keep lighting if it is not turned off.

K7/K8 key (colder /warmer)

Temperature setting switch of the upper zone. Under normal conditions the temperature display will flash and indicate the current temperature of the upper zone. Pressing the K7/K8 key when setting the temperature, the temperature displayed will decrease or increase in an increment of one degree. If the K7 (colder) or K8 (warmer) key is pressed and held for one second, the temperature displayed will decrease or increase in a speed of one degree per second. The temperature display will flash 5 seconds after the temperature been set, and indicates the current temperature.

Defrost

- The ice build-up on the inner back wall during compressor operation will be automatically defrosted in a compressor off cycle.
- When defrosting is in process, only the circulation fans for both zones run.
- Defrost water will drain into the drip tray (on the compressor) and the Water will be evaporate by compressor.

Cleaning Your Appliance

- Upon installation of your new appliance, cleaning it thoroughly is recommended.
- Unplug the unit from the wall outlet.
- Remove all contents.
- Wash the inside with a damp warm cloth soaked in lukewarm water and baking soda solution. The solution should be about 2 tablespoons of baking soda to a quart of water.
- Be sure to keep the door gasket (seal) clean to keep the unit running efficiently.
- The outside of the appliance should be cleaned with mild detergent and warm water.
- Dry the interior and exterior with a soft cloth.
- Dust or anything else blocking the vent may hinder the cooling efficiency of the appliance. Vacuum the vent if necessary.

Vacation Time

- Unplug the unit from the wall outlet.
- Remove all the contents.
- Clean the appliance.
- Leave the door open slightly to avoid possible formation of condensation, mold, or odors.
- **Short vacations:** Leave the appliance operating during vacations of less than three weeks.
- **Long vacations:** If the appliance will not be used for several months, remove all content and unplug the power cord. Clean and dry the interior thoroughly. To prevent odor and mold growth, leave the door open slightly, blocking it open if necessary.

Moving Your Appliance

- Unplug the unit from the wall outlet.
- Remove all the contents.
- Securely tape down all loose items inside your appliance.
- Tape the doors shut.

Energy Saving Tips

- The appliance should be located in the coolest area of the room, away from heat producing appliances or heating ducts, and out of the direct sunlight.
- Ensure that door is closed when the appliance is plugged in.

Problem	Possible cause
Display flash and indicate “HH”, flash speed one time per second	The temperature sensor of zone > 37°
Display flash and indicate “LL”, flash speed one time per second	The temperature sensor of zone < 0°
Display flash and indicate “E0”, flash speed one time per second	Connection failure, wire or component is not connected
Display flash and indicate “E1”, flash speed one time per second	Temperature sensor is failure in corresponding zone
Display flash and indicate “E2”, flash speed one time per second	Error defrost sensor in corresponding zone
Appliance does not operate.	Not plugged in. The circuit breaker has tripped or there is a blown fuse.
Temperature inside the appliance is too warm.	Temperature control is set too warm. Turn the control to a cooler setting and allow several hours for the temperature to stabilize. Door is kept open too long or is opened too frequently. Warm air enters the appliance every time the door is opened. Open the door less often. The door is not closed completely. The door gasket does not seal properly. The appliance has recently been disconnected for a period of time. 4 hours are required for the appliance to cool down completely.
Temperature inside the appliance is too cold.	Temperature control is set too cold. Turn the control to a warmer setting and allow several hours for the temperature to stabilize.
Vibrations	Check to assure that the appliance is on a level surface. The appliance is touching the wall. Re-level the appliance and move it from the wall. If continued vibration occurs, turn off the appliance and unplug the power plug. Contact Customer Service Dept. for further assistance.
Moisture forms on inside appliance walls.	Door is slightly open. Door is kept open too long, or is opened too frequently. Open the door less often. The door is not sealed properly
Moisture forms on outside of appliance.	Door is slightly open, causing cold air from inside the appliance to meet warm moist air from outside
The door will not close properly.	The appliance is not on a level surface. The gasket is dirty.

For service, see our website at www.norcool.com

By checking the above before ordering service, you will help the service engineer know what parts they may need to bring and what measures to take.



Scandinavian Appliances AS
Postboks 61
1740 Borgenhaugen
Norway
T: +47 815 69 117
post@norcool.no
www.norcool.no



Please visit our website for operating & installation instructions in other languages.

Version 1.0 - march 2020